

EVORA - 900 Wall Mounted Double Drawer Unit Installation & Aftercare Instructions

Retain for future reference



Customer Services

Soakology, Unit 5, Brassmill Lane Enterprise Centre Brassmill Lane, Bath, BA1 3JN
t. 0845 862 9888 e. contact@soakology.co.uk w: www.soakology.co.uk

Part of Total Bathroom Enterprises Ltd
VAT No. 153612626 Company No. 8260845

EVORA - 900 Wall Mounted Double Drawer Unit Installation & Aftercare Instructions

IMPORTANT

It is recommended that all units and basins are secured to a suitably reinforced wall to ensure stability. Wall plugs supplied are only suitable for solid stone / brick wall. For plasterboard walls use specialist wall plugs, if in any doubt please consult an expert. Wear suitable eye protection when drilling. Take care when using power tools near water - the use of a residual current device (RCD) is recommended. Beware of hidden pipes or cables. Take care when drilling tiled surfaces as the drill might slip. Use a piece of masking tape to prevent the drill from wandering.

Installation Procedures

1. Mark the location and fix in place both of the wall mounting plates ensuring that they are positioned inside the sidewalls of the unit. We recommend the top of the basin should be 860mm from the floor.
2. Locate the hangers onto the wall mounting plates. Wall hangers not only tighten the unit against the wall (Screw A, bottom) but also offer up/down adjustment to fine-tune the fixing position (Screw B, top).
3. The unit has drawers which can be adjusted up and down. To do so, firstly remove the screws from the underside of the drawer runners. There is a dial that can be used to adjust the height of the drawers towards the front of the drawer. When the drawer is at the desired height, re-insert the screws into the drawer to secure into the new position.
4. Once the furniture unit is secured, plumb in the basin and secure to the unit using a silicone sealant (not provided).

Aftercare

We recommend that after use, you wipe away any water splashes or condensation from the furniture. Excessive exposure to water will deteriorate the furniture and can damage it. All bathrooms should be well ventilated with a suitable extractor fan. When cleaning, use a soft damp cloth only.

Do NOT scrub or scour the unit, or use any abrasive cleaning agents.

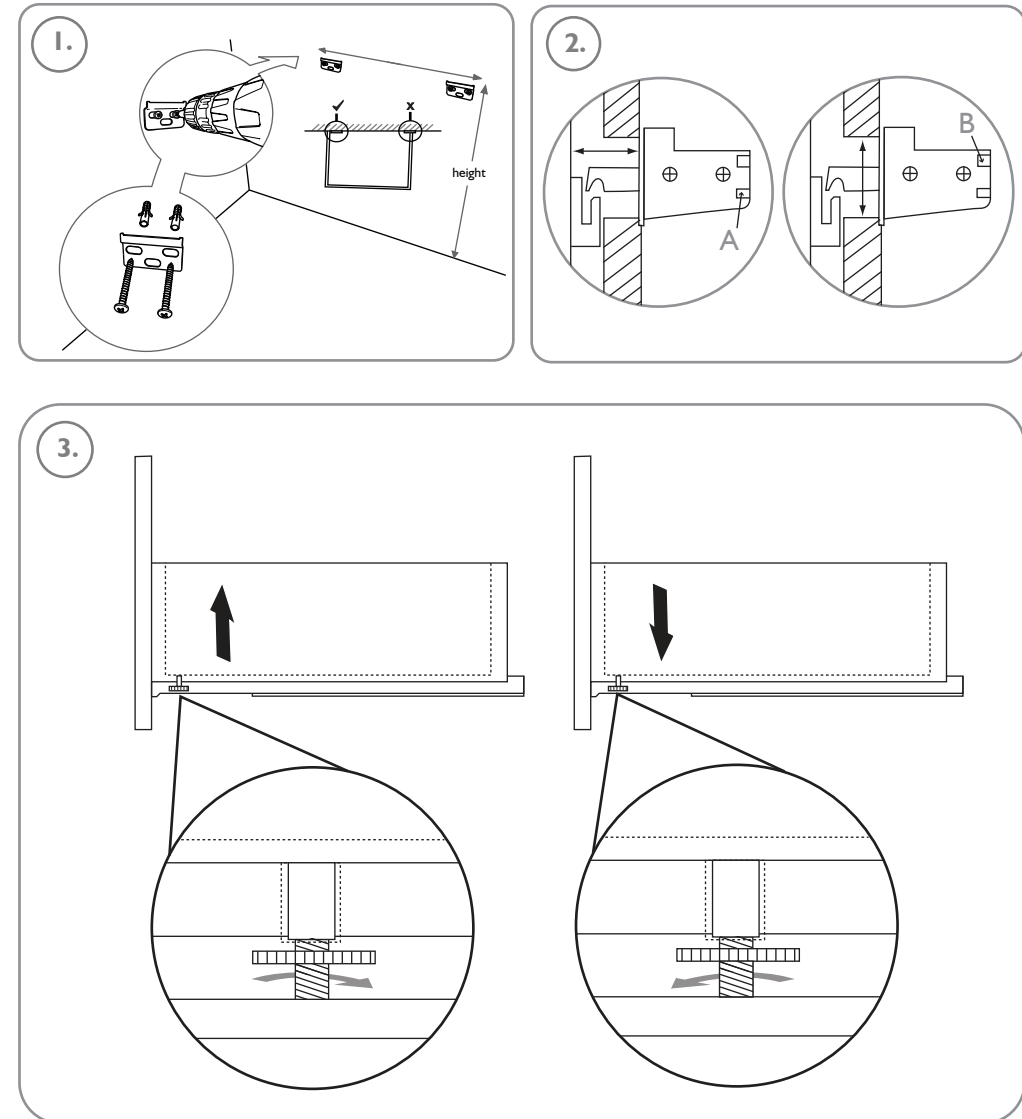

Customer Services

Soakology, Unit 5, Brassmill Lane Enterprise Centre Brassmill Lane, Bath, BA1 3JN
t. 0845 862 9888 e. contact@soakology.co.uk w: www.soakology.co.uk