

Laguna Shower System Installation Instructions

SK11057

Please retain for future reference

Soakology, Unit 5,
Brassmill Lane Enterprise Centre,
Bath, BA1 3JN
t. 0845 862 9888
e. contact@soakology.co.uk
w. www.soakology.co.uk



Contents

Rail Assembly
(Pre-assembled)

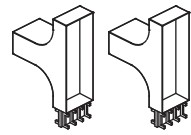

2 x Wall Brackets

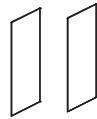

2 x Wall Bracket Covers



1 x Riser Rail

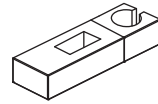

1 x Handset Bracket



2 x Wall Plugs & Screws



1 x Handset



2 x Rubber Washers for
Shower Hose



1 x Shower Hose

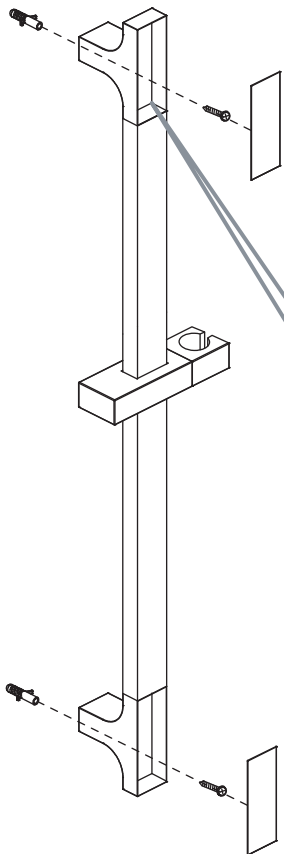

1. Remove the wall bracket covers from the rail assembly .

2. Offer the assembly up to the wall in the desired location relative to the shower valve and mark the fixing points through the holes in the wall brackets. Drill with a masonry drill bit of appropriate diameter. Use the supplied wall plugs or fixings appropriate to the wall material. Replace cover caps.

Mark fixing points.

Drill with masonry drill bit
of appropriate diameter

REMEMBER

Wear suitable eye protection when drilling. Take care when using power tools near water - the use of a residual current device (RCD) is advised. Beware of hidden cables or pipes. When drilling tiled surfaces, a piece of masking tape applied to the wall before marking out the fixing holes will stop the drill wandering.

3. Attach the shower hose to the handset and the bar valve, making sure to include the rubber washer at either end .

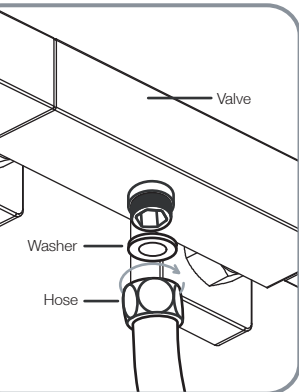
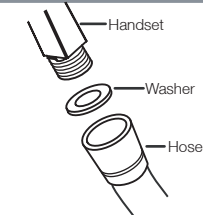
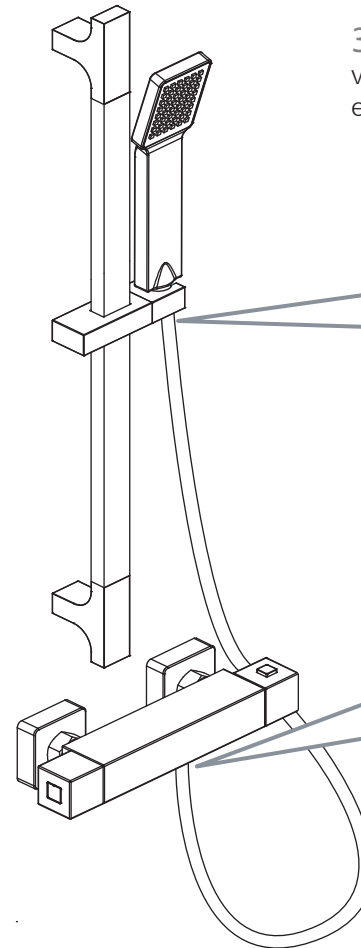

Refer to separate instructions
for valve installation