

INSTALLATION INSTRUCTIONS

Sapphire Tall basin mixer
without pop up waste

CTA12

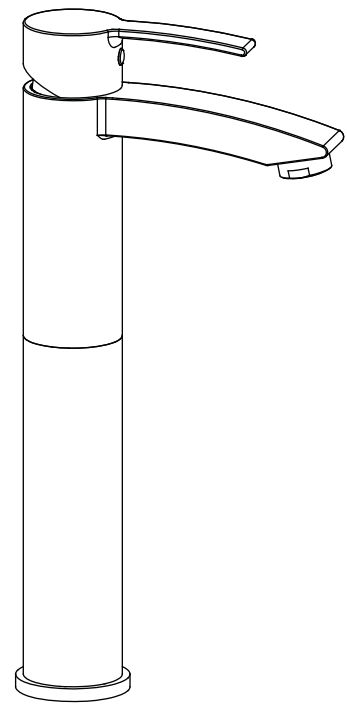

Important

- We recommend that this product is installed by a qualified professional contractor. Such as a plumber who is certified by NVQ (National Vocational Qualification) or SNVQ (Scottish National Vocational Qualification) Level 3.
- Please check this product immediately to ensure that it has not been damaged and is complete. Before installation, please make sure this product is the correct model and you have all the parts required for installation and using.
- All the taps should be supplied with hot and cold water at balanced pressure. If not, then the mixing function will not work correctly. It is necessary to fit non-return valves on both hot and cold feeds pipe. These are not supplied.
- Please flush the water system to ensure that no metal swarf, solder, and other impurities can enter the taps.
- Turn off water supply before commencing work, this should be done at the isolating valves of inlet feeds if fitted or main stopcock.
- Please read these instructions carefully and keep it for future reference.

Working pressure

The tap is suitable for both high and low pressure installation. To ensure that the tap works well under low water pressure, the cold water storage tank must be at least 2 meters above the installed position. The maximum water pressure is 6 bar. Where the water pressure above 6 bar, then a pressure reducing valve must be fitted.

Straightener and aerator (alternative option)

Taps are all fitted with a flow straightener for use in low pressure installations. An aerator is supplied in the box, and is an option that can be used in high pressure installations. These can be interchanged by unscrewing the part, and replacing with the alternate one. During the process do not loose the washer, between the parts.

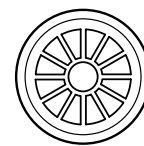

FLOW STRAIGHTENER

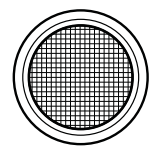

AERATOR

Cleaning

Before use: Unscrew the filter and allow the water to run freely for 5 minutes. Then screw the filter back in place.

Periodically: Unscrew the nozzle and remove. Rinse it with running water until any loose debris is cleared. Then replace the nozzle and tighten.

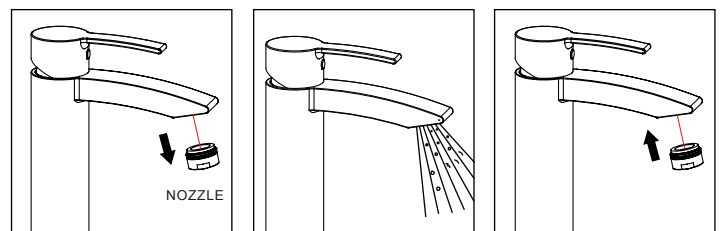

Maintenance

We do NOT recommend you use any household cleaners to clean the product. Because these cleaners change substance or formula too frequently. The product should be always cleaned only with soapy water and rinsed with clean water and dried with a soft cloth.

Dimension

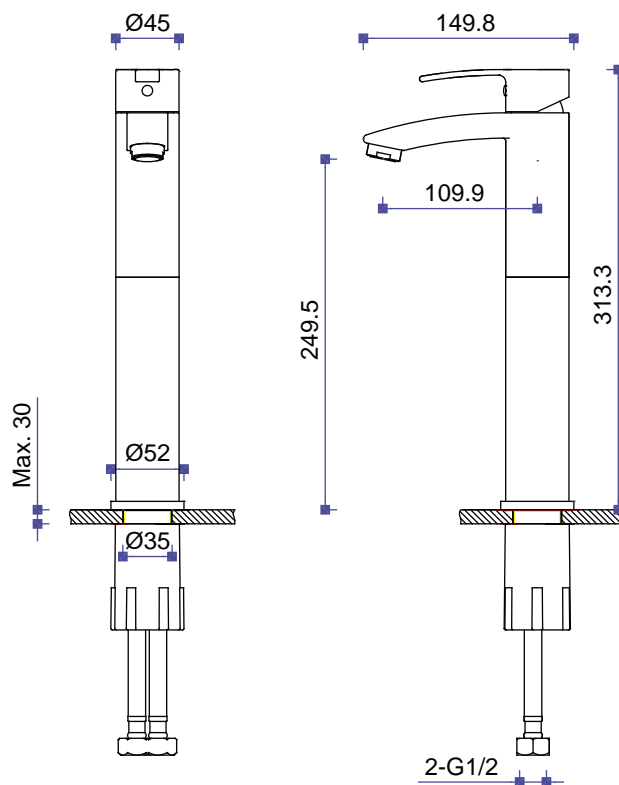

Installation

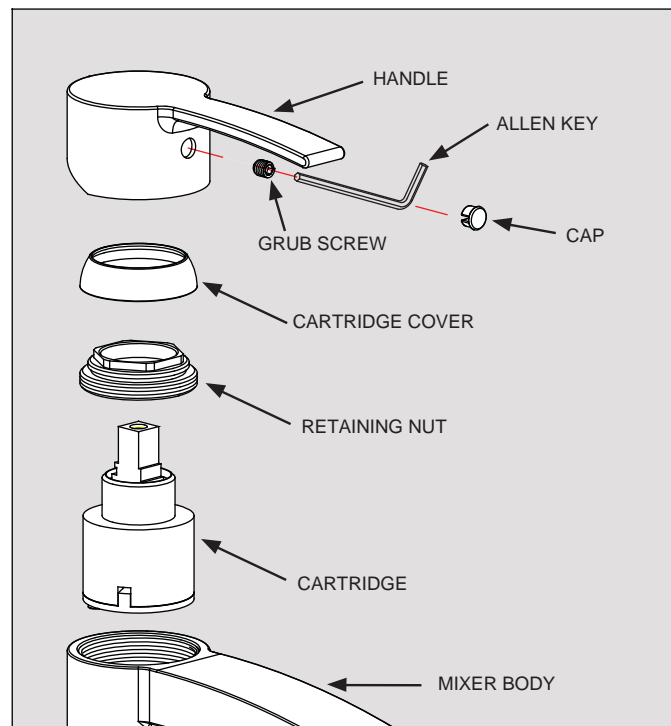
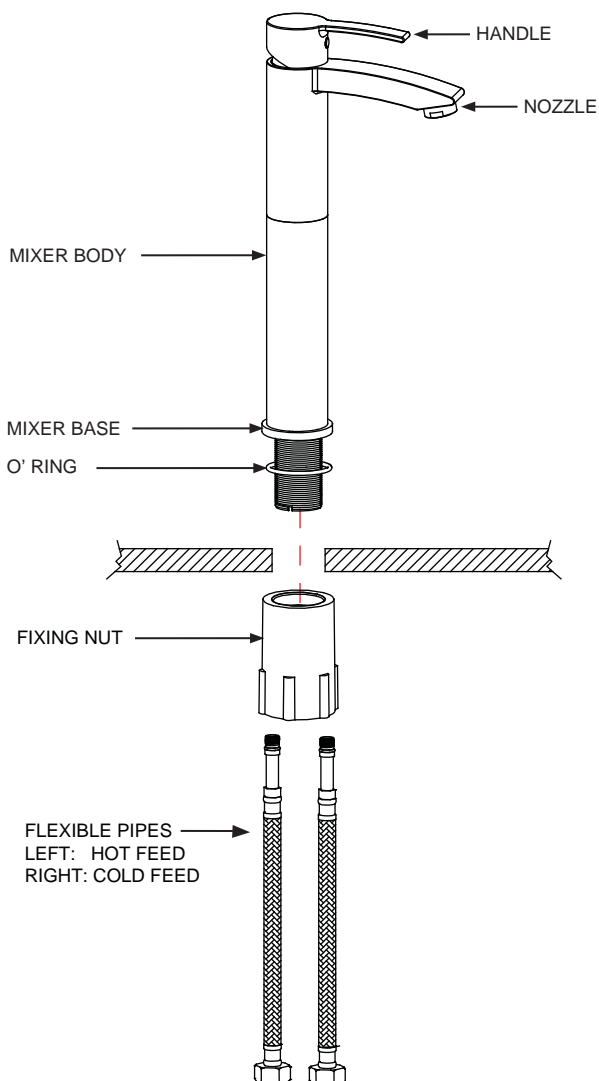

To remove the cartridge.

⚠ First shut off the water supply to the tap.

- 1: Pull out the cap from the handle.
- 2: Loosen the grub screw in handle, but do not remove it.
- 3: Take off the handle, unscrew the cartridge cover.
- 4: Using a correct size spanner unscrew the retaining nut.
- 5: Pull the cartridge and wash it with clean running water.
- 6: Dry and lightly grease the seals (only use silicone grease)
- 7: Replace them in turn.

- 1: Fit the O' ring into the groove in the underside of the mixer body.
- 2: Screw the flexible pipes into the mixer body, and fully hand tighten.
- 3: Pass the tail of flexible pipes through the hole on the basin from above, and place the mixer in position on the basin, to see if any alteration to the existing supply pipe work is necessary, make any necessary alterations to the pipe work.
- 4: Slide the fixing nut up the tails and onto the fixing bolt.
- 5: Check that the mixer body is correctly positioned, fully tighten the fixing nut.
- 6: Connect the water supply pipe to the tail of flexible pipes with the hot water on the left and cold water on the right.